

Arboga II 40 (380x380)

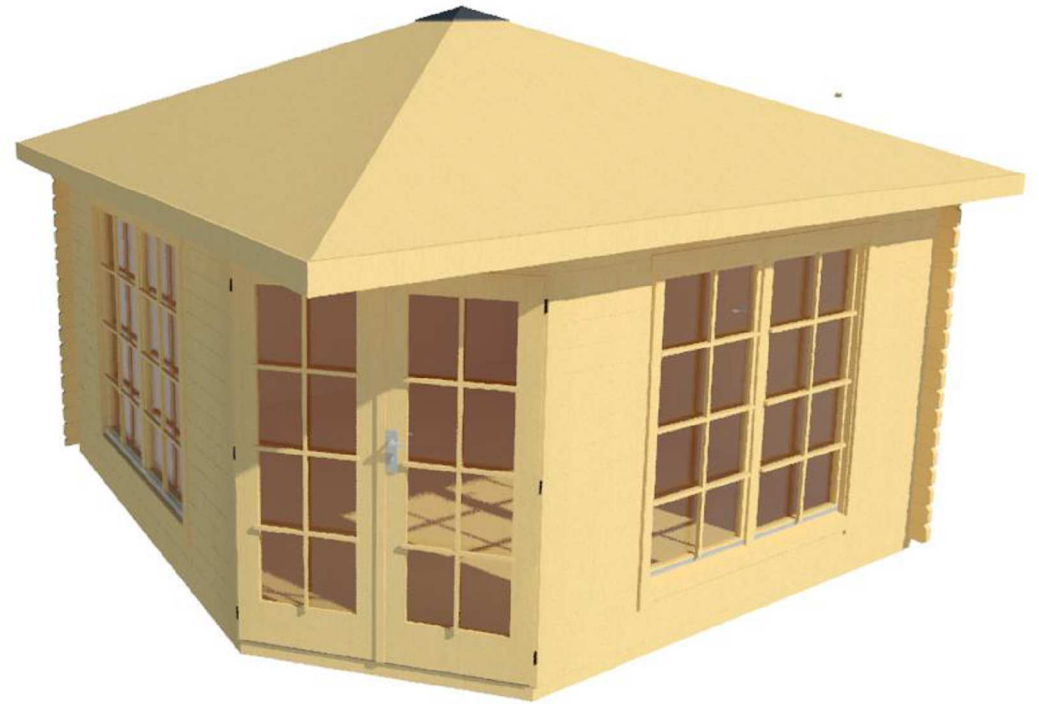

4100002_220316

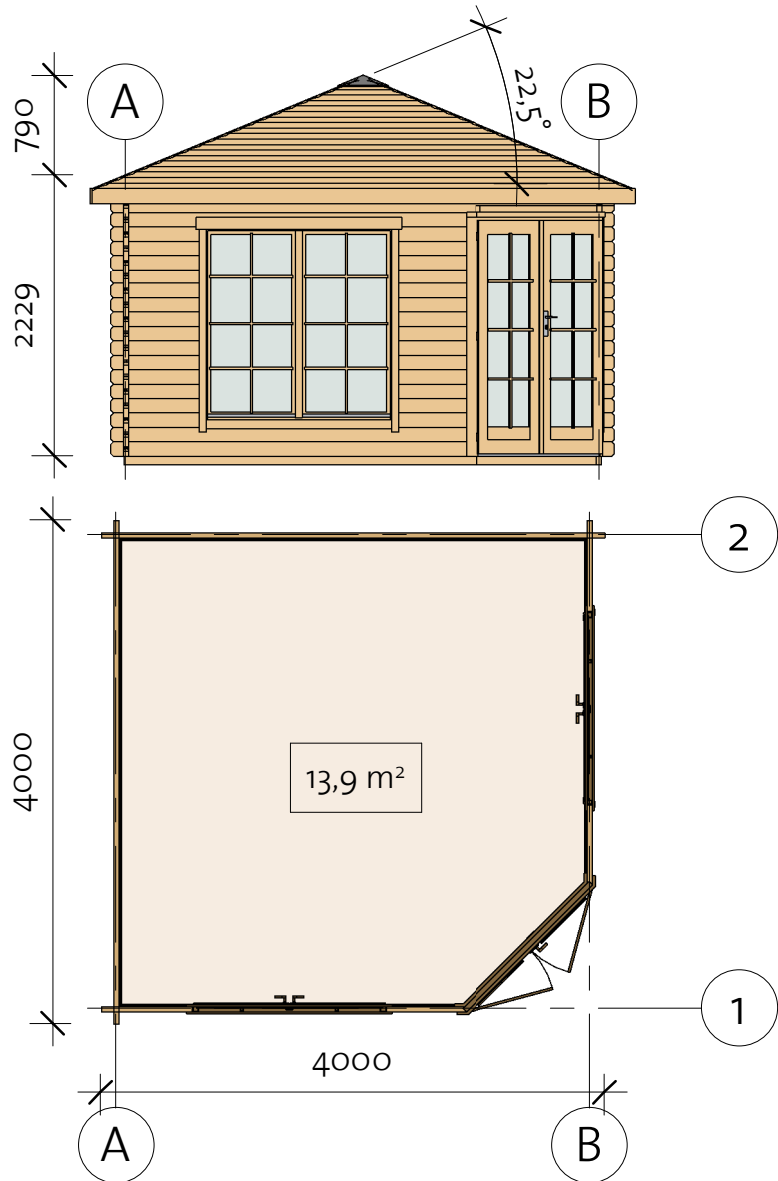

Arboga II 40 (380x380)

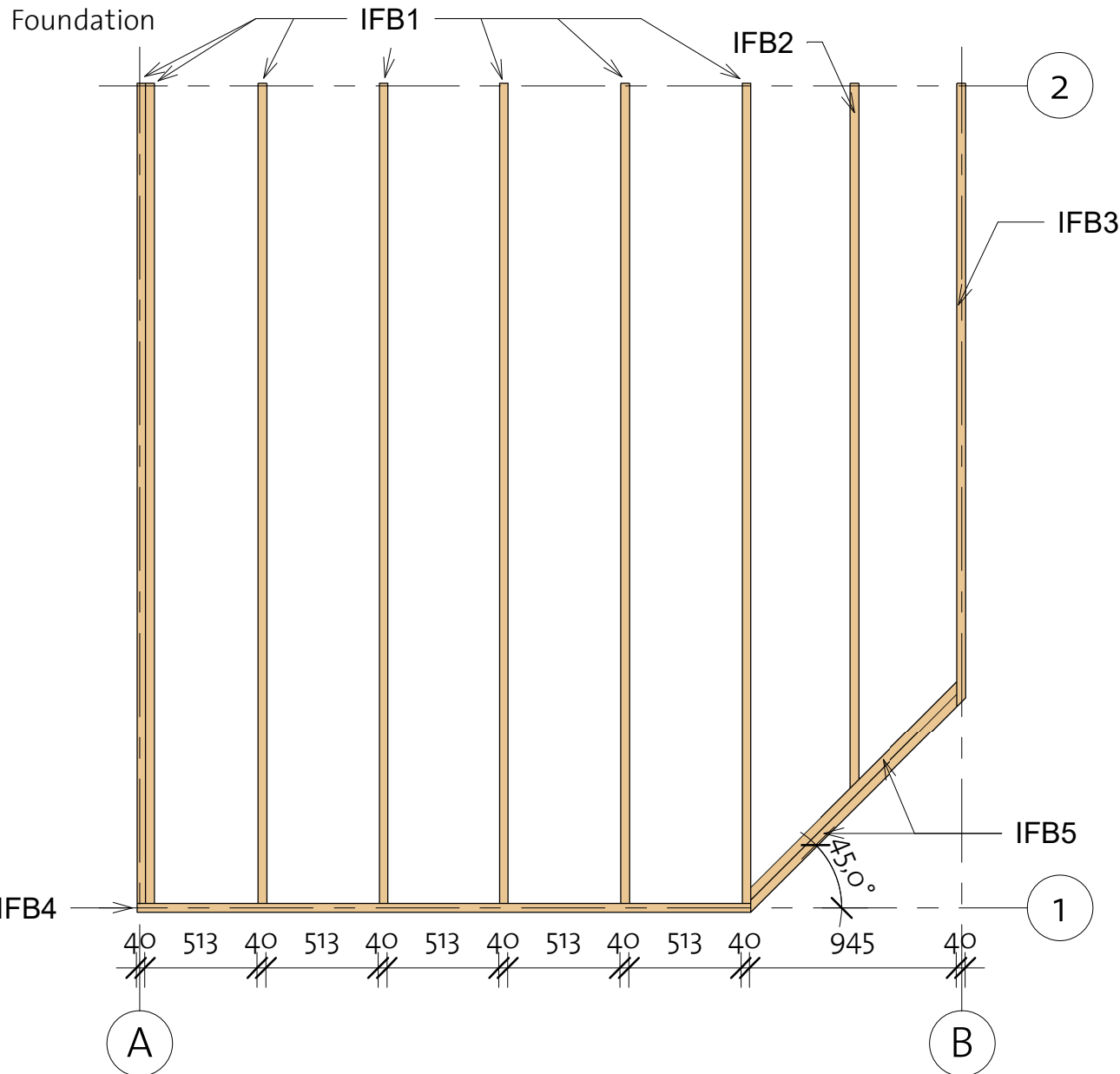

Impregnated foundation beams				
Mark	Type	Profile	Count	Length
IFB1	IFB 40x70		7	3750
IFB2	IFB 40x70		1	3224
IFB3	IFB 40x70		1	2845
IFB4	IFB 40x70		1	2805
IFB5	IFB 40x70		2	1376

Arboga II 40 (380x380)

Floor Plan

① Baseboard

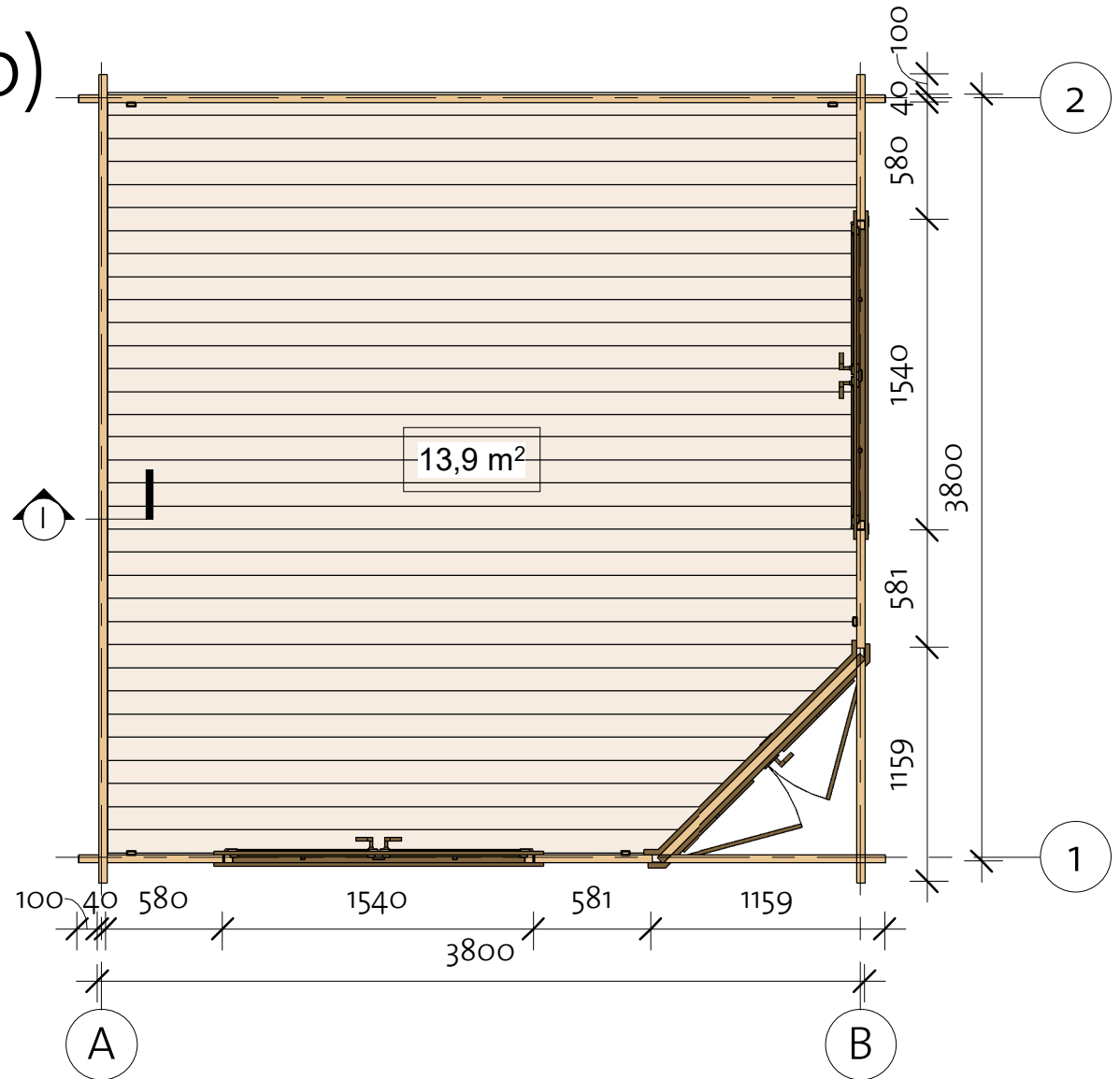
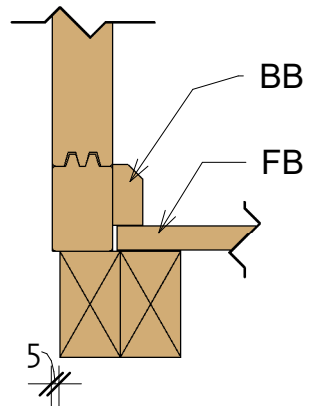

Floor Schedule

Mark	Type	Profile	Count	Length
------	------	---------	-------	--------

FB 1	FB 17x114		1	2861
FB 2	FB 17x114		1	2975
FB 3	FB 17x114		1	3089
FB 4	FB 17x114		1	3203
FB 5	FB 17x114		1	3317
FB 6	FB 17x114		1	3431
FB 7	FB 17x114		1	3545
FB 8	FB 17x114		1	3659
FB 9	FB 17x114		1	3717
FB 10	FB 17x114		25	3717

BB	BB 20x40		4	3800
----	----------	---------------------------------------------------------------------------------------	---	------

4100002_200409

Arboga II 40 (380x380)

Wall 1

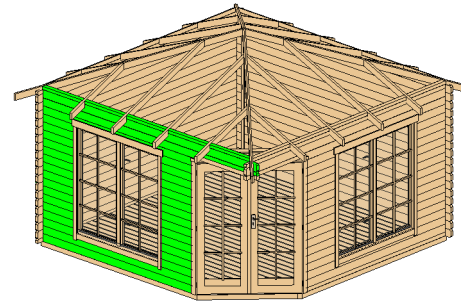

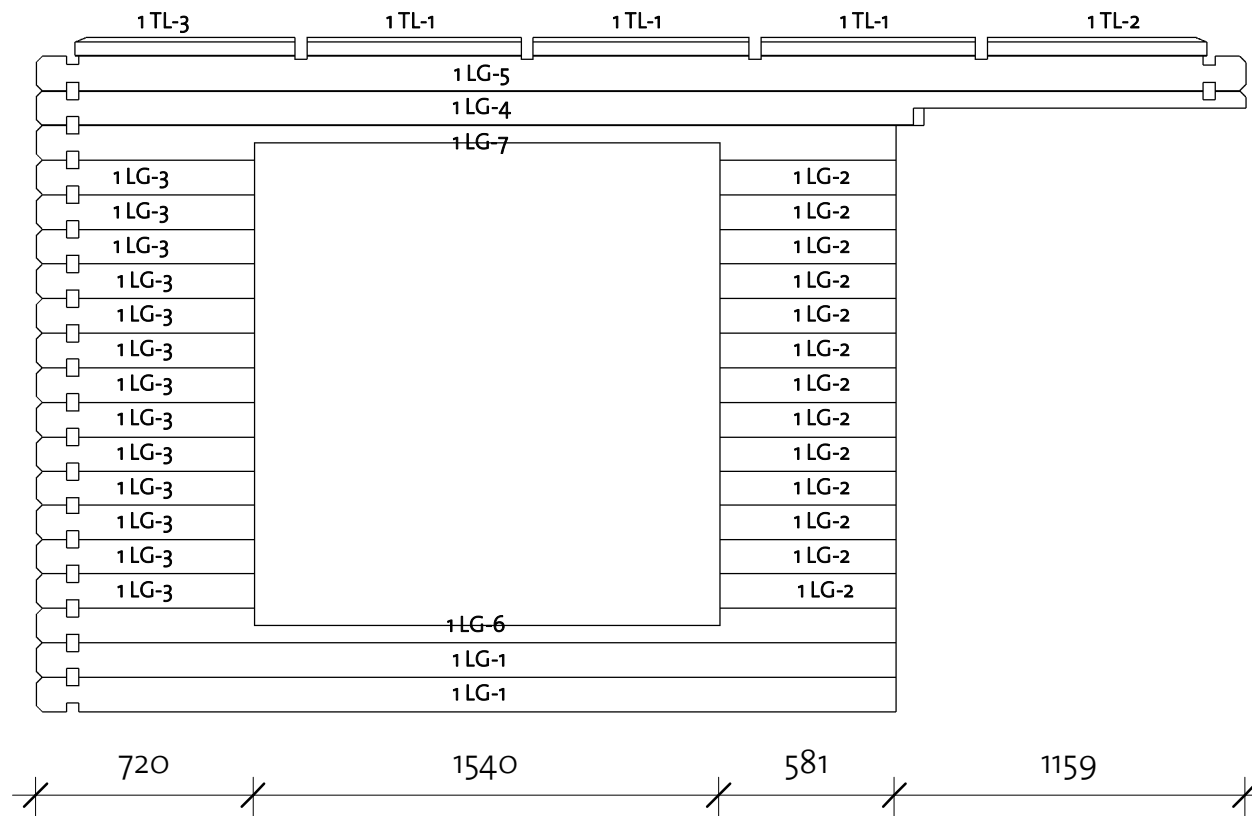

Wall 1			
Mark	Profile	Count	Cut Length

1LG-1	40x114	2	2841
1LG-2	40x114	13	581
1LG-3	40x114	13	720
1LG-4	40x114	1	4000
1LG-5	40x114	1	4000
1LG-6	40x114	1	2841
1LG-7	40x114	1	2841
1TL-1	40x63	3	711
1TL-2	40x63	1	725
1TL-3	40x63	1	725

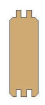

Log Profile Wall 1	
Profile	Profile

40x114	
40x63	

Arboga II 40 (380x380)

Wall 2

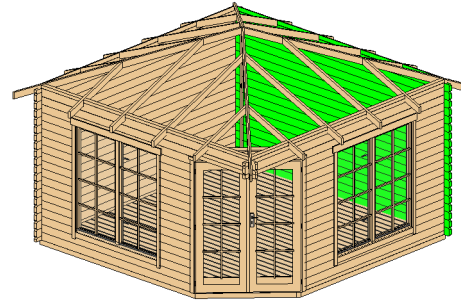

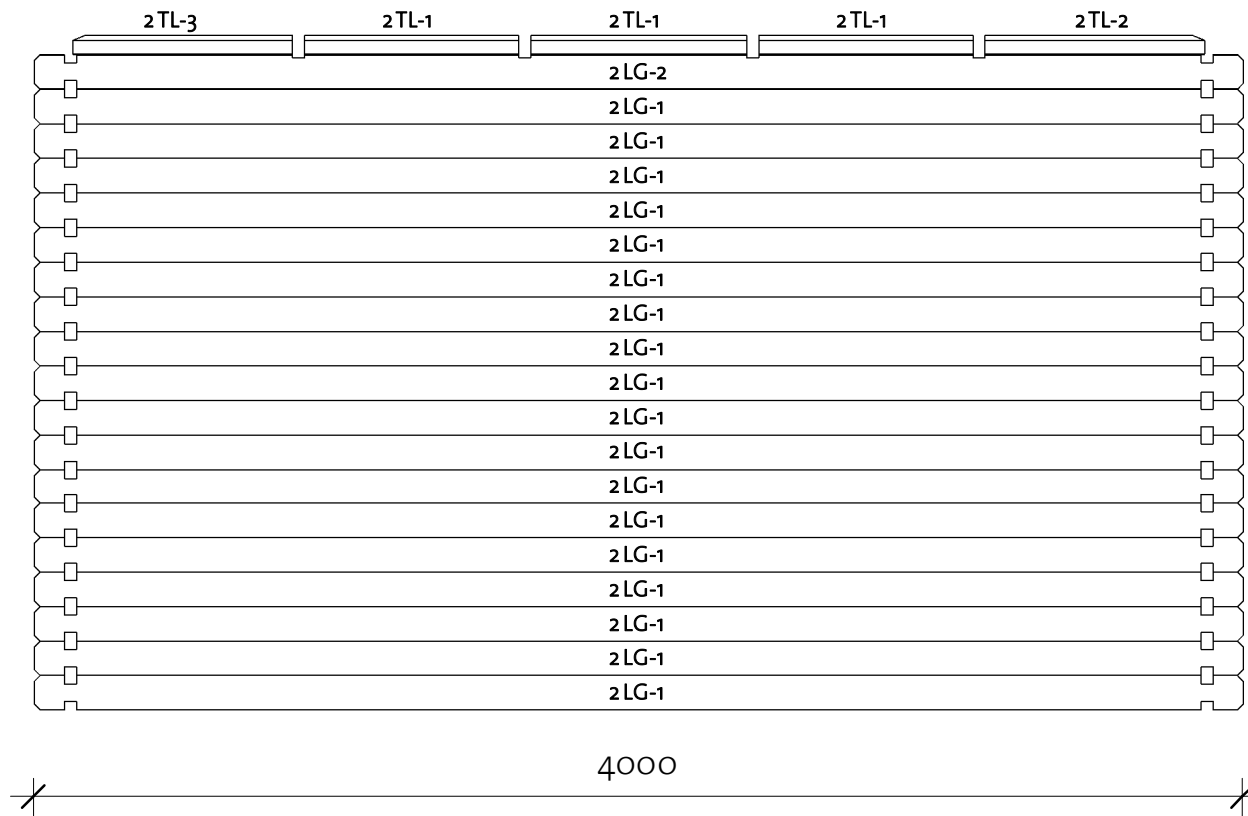

Wall 2			
Mark	Profile	Count	Cut Length

2LG-1	40x114	18	4000
2LG-2	40x114	1	4000
2TL-1	40x63	3	711
2TL-2	40x63	1	725
2TL-3	40x63	1	725

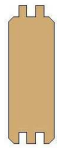

Log Profile Wall 2	
Profile	Profile



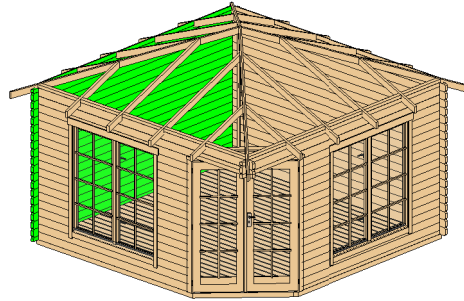

40x114	
40x63	

Arboga II 40 (380x380)

Wall A



Wall A			
Mark	Profile	Count	Cut Length
ATL-1	40x63	3	711
ATL-2	40x63	1	725
ATL-3	40x63	1	725
ABL-1	40x57	1	4000
ALG-1	40x114	18	4000
ATL-4	40x57 TL	1	4000

Log Profile Wall A	
Profile	Profile
40x57	
40x57 TL	
40x63	
40x114	

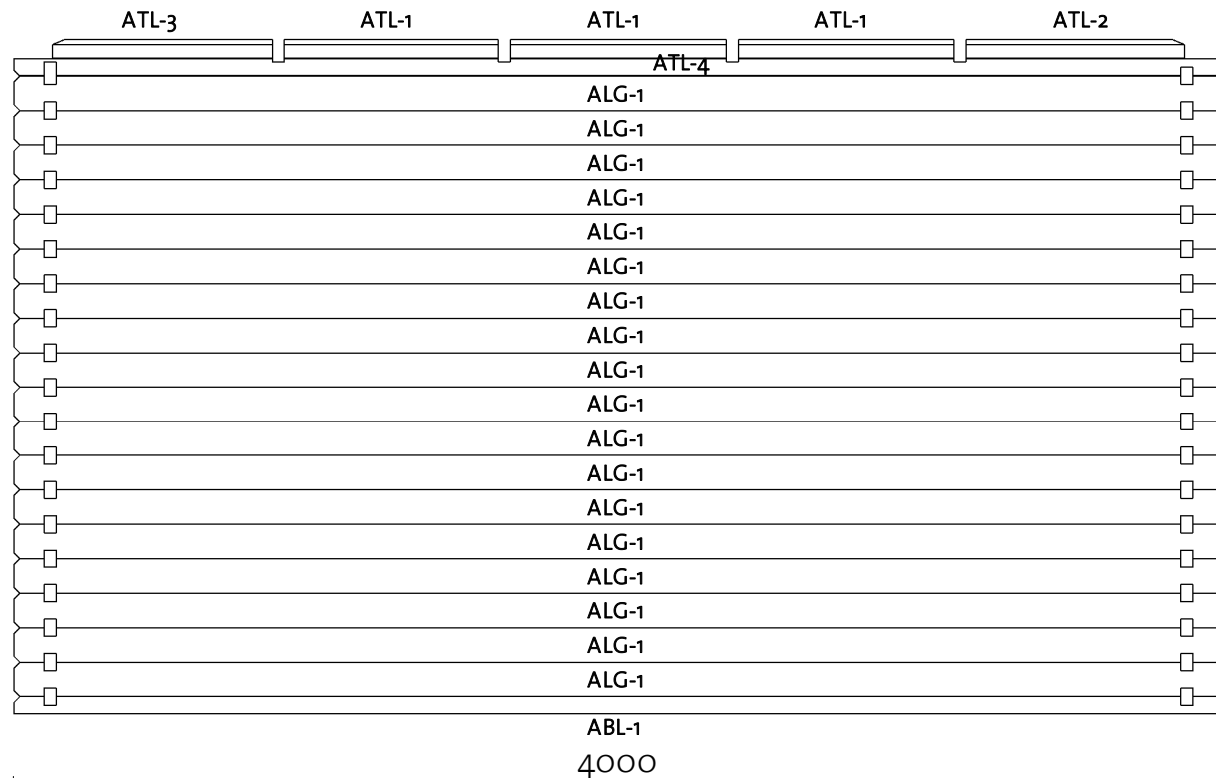

Arboga II 40 (380x380)

Wall B

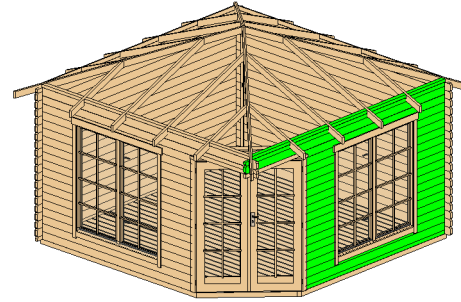



Wall B			
Mark	Profile	Count	Cut Length

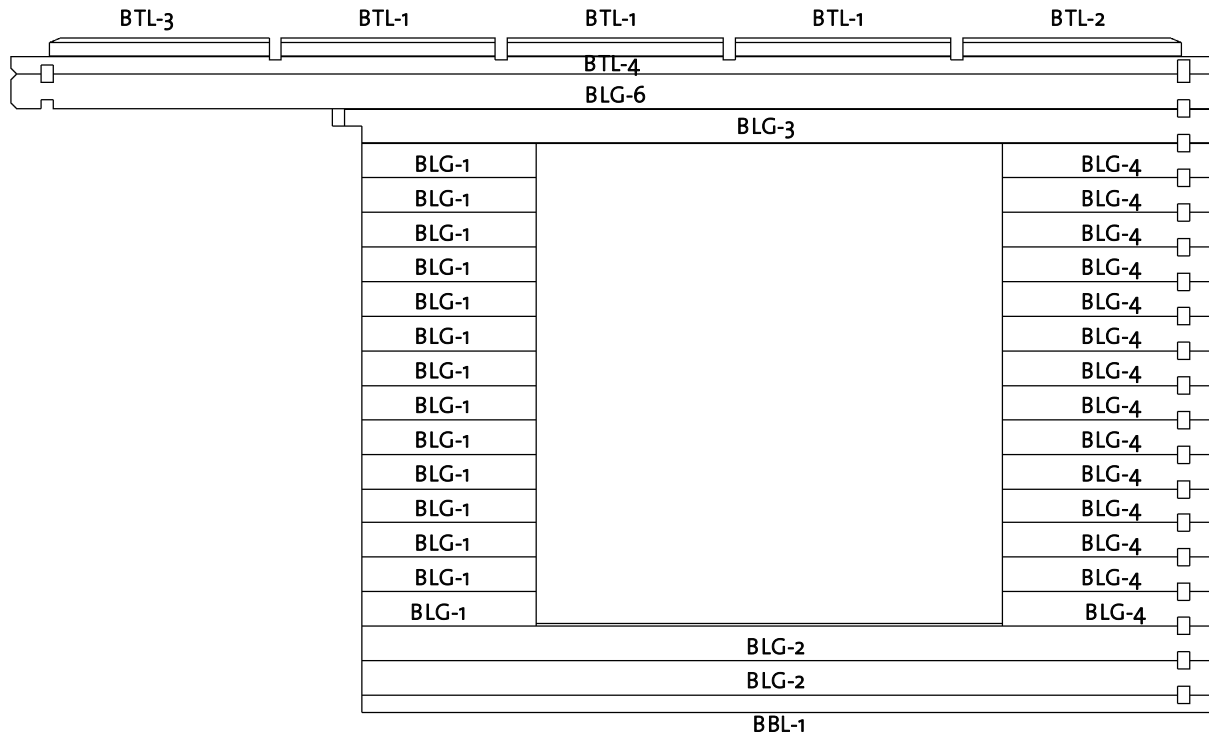

BTL-1	40x63	3	711
BTL-2	40x63	1	725
BTL-3	40x63	1	725
BBL-1	40x57	1	2841
BLG-1	40x114	14	581
BLG-2	40x114	2	2841
BLG-3	40x114	1	2938
BLG-4	40x114	14	720
BLG-6	40x114	1	4000
BTL-4	40x57 TL	1	4000



Log Profile Wall B	
Profile	Profile

Log Profile Wall B	
Profile	Profile

40x57	
40x57 TL	

40x63	
40x114	

Arboga II 40 (380x380)

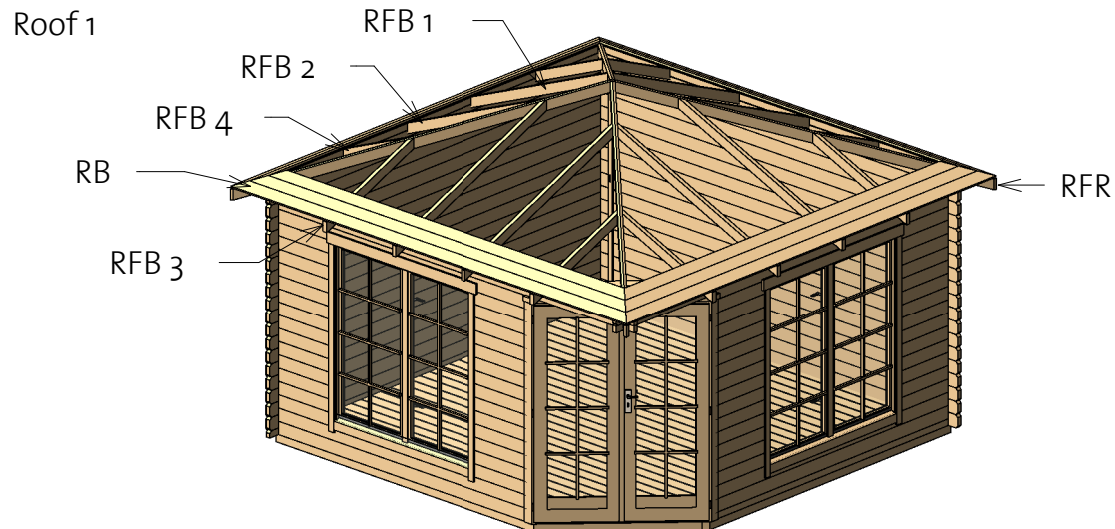

Roof				
Mark	Type	Profile	Count	Length

RFR	40x94		4	3172
RFB4	40x85		4	1132
RFB3	40x85		4	1132
RFB2	40x85		4	1945
RFB1	40x85		4	1945

Roofboards				
Mark	Type	Profile	Count	Length

RB 1	RoofBoard 17x114		4	292
RB 2	RoofBoard 17x114		4	503
RB 3	RoofBoard 17x114		4	714
RB 4	RoofBoard 17x114		4	924
RB 5	RoofBoard 17x114		4	1135
RB 6	RoofBoard 17x114		4	1345
RB 7	RoofBoard 17x114		4	1556
RB 8	RoofBoard 17x114		4	1767
RB 9	RoofBoard 17x114		4	1977

Roofboards				
Mark	Type	Profile	Count	Length

RB 10	RoofBoard 17x114		4	2188
RB 11	RoofBoard 17x114		4	2399
RB 12	RoofBoard 17x114		4	2609
RB 13	RoofBoard 17x114		4	2820
RB 14	RoofBoard 17x114		4	3031
RB 15	RoofBoard 17x114		4	3241
RB 16	RoofBoard 17x114		4	3452
RB 17	RoofBoard 17x114		4	3663
RB 18	RoofBoard 17x114		4	3873
RB 19	RoofBoard 17x114		4	4084
RB 20	RoofBoard 17x114		4	4294

Arboga II 40 (380x380)

Roof 2

Fascia Schedule				
Mark	Type	Profile	Count	Length
RF	Roof Fascia 18x120		4	4314

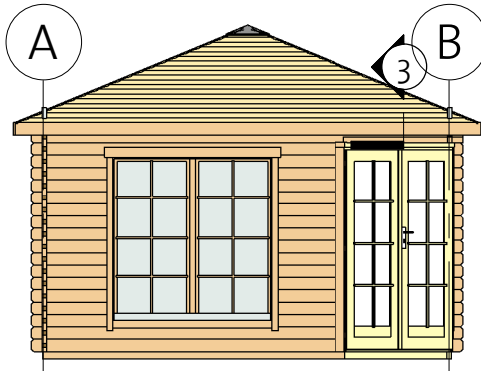

3 Facia

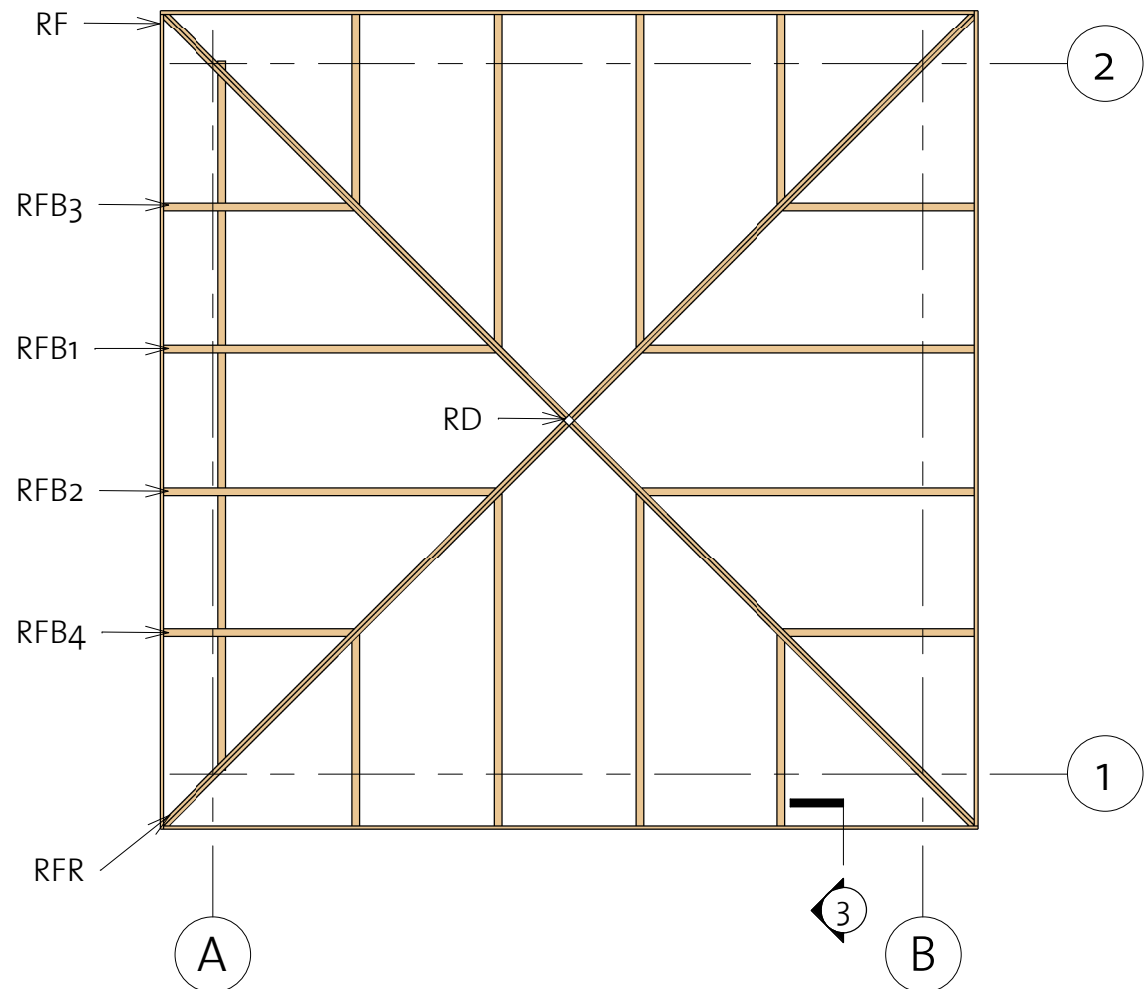
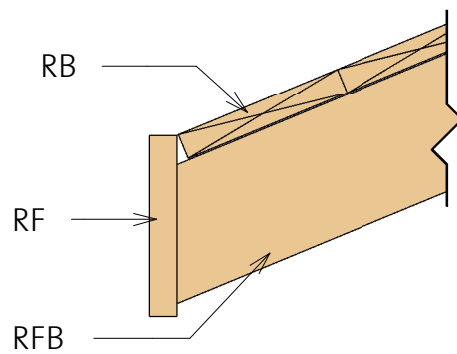

Arboga II 40 (380x380)

Extras

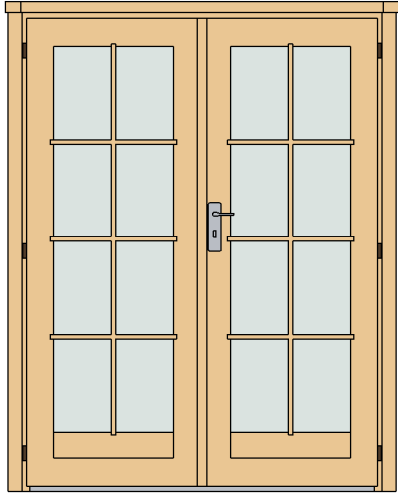

Door Schedule				
Model	Type	Width	Height	Count

CDD4R	Classic double door 4 right	1425	1900	1
-------	-----------------------------	------	------	---

DCB8	Door crossbar 8	--	--	2
------	-----------------	----	----	---

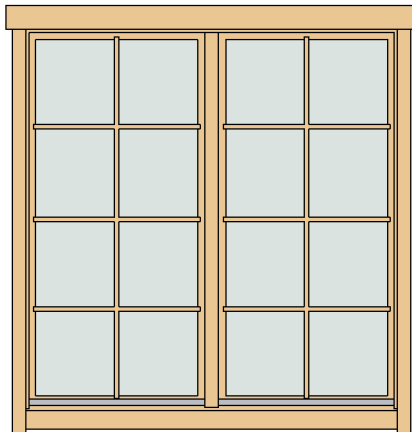

Window Schedule				
Model	Type	Width	Height	Count

CDW4	Classic double window 4	1530	1555	2
------	-------------------------	------	------	---

WCB8	Window crossbar 8	--	--	4
------	-------------------	----	----	---

- * Windows intended for tilt opening only!
- * Fenster zur Eröffnung nur zum Kippen vorgesehen!
- * Aknad on ette nähtud ainult kaldu avamiseks!

4100002_220316



Type	Count	Length
------	-------	--------

Windboard 18x40	5	2200
-----------------	---	------

Roof Detail		
Mark	Type	Count

RD	Roof detail	1
----	-------------	---



Fasteners/Extras		
Name	Type	Count

Hitblock	300-400 mm	
Bolts	M8 x 70	15
Nails	1,4 x 40	40
Screws	5,0 x 70	60
Screws	6,0 x 140	110
Screws	4,0 x 40	915

① Roof top 23°

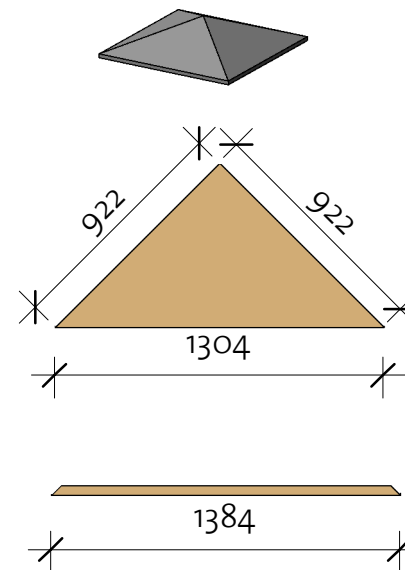

Type	Mark	Count
------	------	-------

Ceiling detail 40x120	CD	1
Ceiling triangle	CT	1

Arboga II 40 (380x380)

List of all items 1

Impregnated foundation beams

Mark	Type	Profile	Count	Length
IFB1	IFB 40x70		7	3750
IFB2	IFB 40x70		1	3224
IFB3	IFB 40x70		1	2845
IFB4	IFB 40x70		1	2805
IFB5	IFB 40x70		2	1376

Floor Schedule

Mark	Type	Profile	Count	Length
FB 1	FB 17x114		1	2861
FB 2	FB 17x114		1	2975
FB 3	FB 17x114		1	3089
FB 4	FB 17x114		1	3203
FB 5	FB 17x114		1	3317
FB 6	FB 17x114		1	3431
FB 7	FB 17x114		1	3545
FB 8	FB 17x114		1	3659
FB 9	FB 17x114		1	3717
FB 10	FB 17x114		25	3717

BB	BB 20x40		4	3800
----	-------------	---------------------------------------------------------------------------------------	---	------

Arboga II 40 (380x380)

List of all items 2

Wall 1			
Mark	Profile	Count	Cut Length

1LG-1	40x114	2	2841
1LG-2	40x114	13	581
1LG-3	40x114	13	720
1LG-4	40x114	1	4000
1LG-5	40x114	1	4000
1LG-6	40x114	1	2841
1LG-7	40x114	1	2841
1TL-1	40x63	3	711
1TL-2	40x63	1	725
1TL-3	40x63	1	725

Wall A			
Mark	Profile	Count	Cut Length

ATL-1	40x63	3	711
ATL-2	40x63	1	725
ATL-3	40x63	1	725
ABL-1	40x57	1	4000
ALG-1	40x114	18	4000
ATL-4	40x57 TL	1	4000



Wall 2			
Mark	Profile	Count	Cut Length

2LG-1	40x114	18	4000
2LG-2	40x114	1	4000
2TL-1	40x63	3	711
2TL-2	40x63	1	725
2TL-3	40x63	1	725

Wall B			
Mark	Profile	Count	Cut Length

BTL-1	40x63	3	711
BTL-2	40x63	1	725
BTL-3	40x63	1	725
BBL-1	40x57	1	2841
BLG-1	40x114	14	581
BLG-2	40x114	2	2841
BLG-3	40x114	1	2938
BLG-4	40x114	14	720
BLG-6	40x114	1	4000
BTL-4	40x57 TL	1	4000

Log Profiles	
Profile	Profile

40x114	
40x63	

Log Profiles	
Profile	Profile



40x57	
40x57 TL	

Arboga II 40 (380x380)

List of all items 3

Roof				
------	--	--	--	--

Mark	Type	Profile	Count	Length
------	------	---------	-------	--------

RFR	40x94		4	3172
RFB4	40x85		4	1132
RFB3	40x85		4	1132
RFB2	40x85		4	1945
RFB1	40x85		4	1945

Roofboards				
------------	--	--	--	--

Mark	Type	Profile	Count	Length
------	------	---------	-------	--------

RB 1	RoofBoard 17x114		4	292
RB 2	RoofBoard 17x114		4	503
RB 3	RoofBoard 17x114		4	714
RB 4	RoofBoard 17x114		4	924
RB 5	RoofBoard 17x114		4	1135
RB 6	RoofBoard 17x114		4	1345
RB 7	RoofBoard 17x114		4	1556
RB 8	RoofBoard 17x114		4	1767
RB 9	RoofBoard 17x114		4	1977

Roofboards				
------------	--	--	--	--

Mark	Type	Profile	Count	Length
------	------	---------	-------	--------

RB 10	RoofBoard 17x114		4	2188
RB 11	RoofBoard 17x114		4	2399
RB 12	RoofBoard 17x114		4	2609
RB 13	RoofBoard 17x114		4	2820
RB 14	RoofBoard 17x114		4	3031
RB 15	RoofBoard 17x114		4	3241
RB 16	RoofBoard 17x114		4	3452
RB 17	RoofBoard 17x114		4	3663
RB 18	RoofBoard 17x114		4	3873
RB 19	RoofBoard 17x114		4	4084
RB 20	RoofBoard 17x114		4	4294

Fascia Schedule				
-----------------	--	--	--	--

Mark	Type	Profile	Count	Length
------	------	---------	-------	--------

RF	Roof Fascia 18x120		4	4314
----	-----------------------	-------------------------------------------------------------------------------------	---	------

Windboard

① Windboard Assembly 1



② Windboard Assembly 2

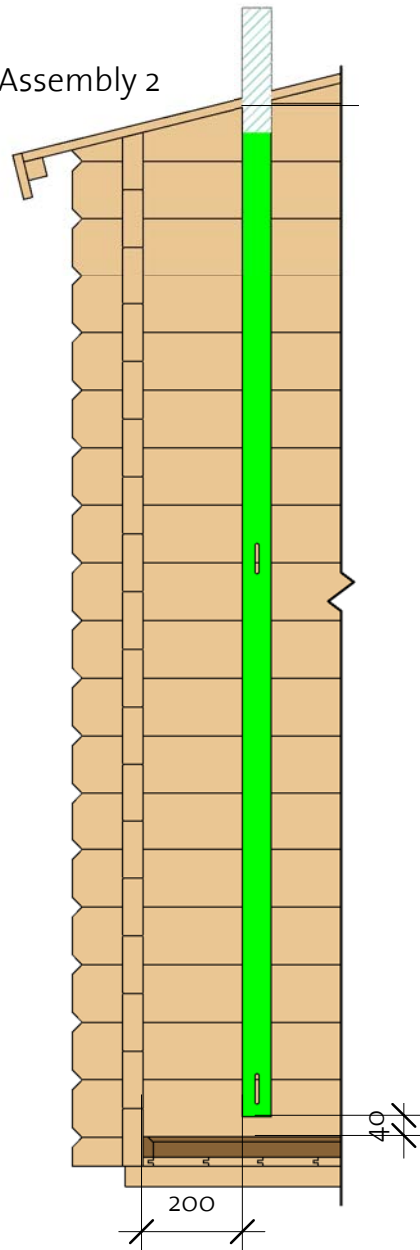

③ Windboard Assembly 3

